

SGC Technologies, Inc.

PRODUCT SPECIFICATION FOR INFORMATION

PRODUCT NAME: SBP-2R6 TYPE

PART NO: SBP-2R6-2904BP20A

Center frequency	2904MHz
Pole	2
Bandwidth(BW)	F _o ±10MHz
Insertion Loss	1.5 dB max
Return Loss	15dB min
Ripple in BW	0.3 dB max
Attenuation	-1436MHz at 55dBc + 1436MHz at 35dBc
In/Out Impedance	50 ohm

NOTE: EQUIPMENT used :HP 8753E

DIMENSION:

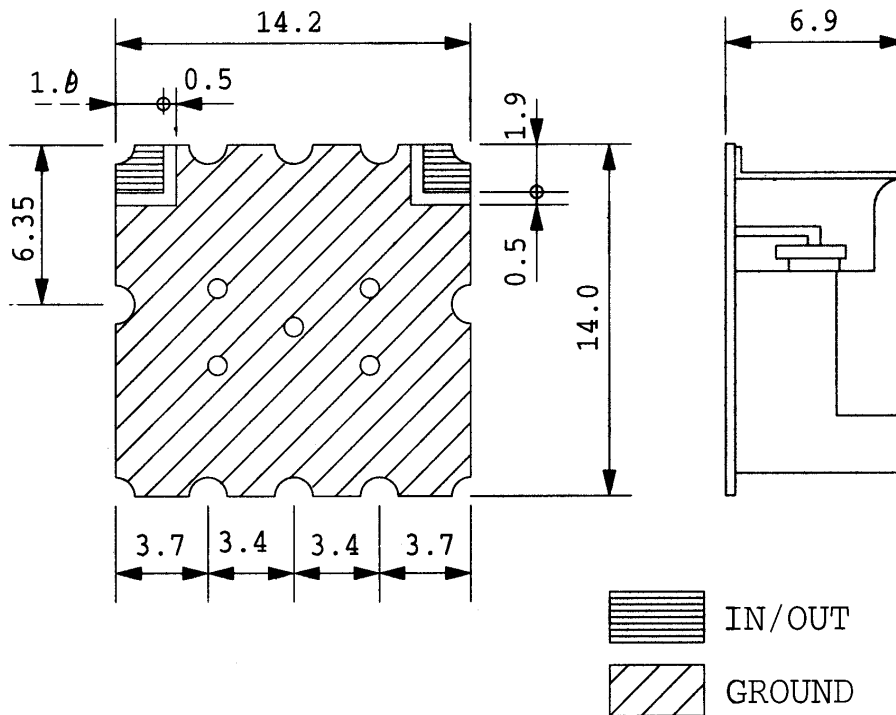

Unit:mm

SBP-2R6-2904BP20A

