

# SGC Technologies, Inc.

## PRODUCT SPECIFICATION FOR INFORMATION

**PRODUCT NAME: SBP-3R3 TYPE**

**PART NO: SBP-3R3-2159BP20B**

Center frequency	2159MHz
Pole	3
Bandwidth(BW)	Fo ±10 MHz
Insertion Loss	3.5dB max
VSWR in BW	1.4 max
Ripple in BW	0.5dB max
Attenuation	Fo ±70MHz at 30dB min
In/Out Impedance	50 ohm

**NOTE:**

EQUIPMENT used :HP 8753E

**DIMENSION:**

**TOP VIEW**

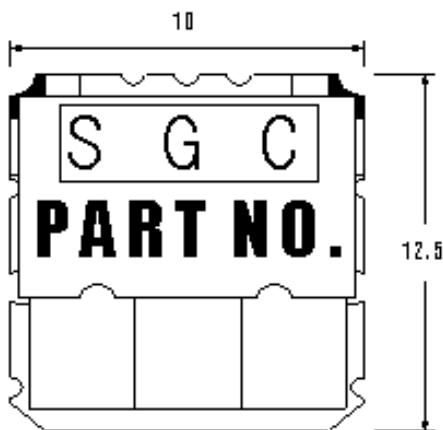

**SIDE VIEW**

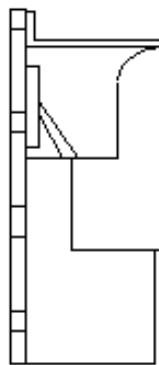

**BOTTOM VIEW**

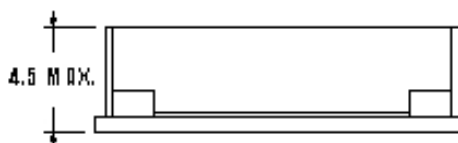
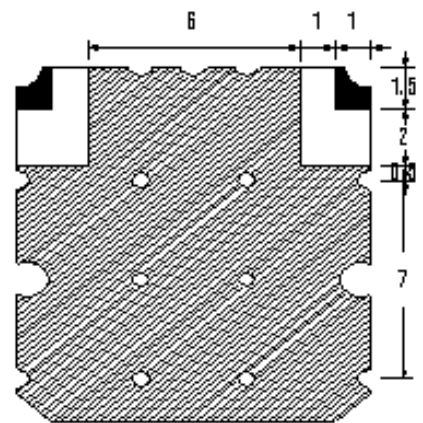

**TOLERANCE UNLESS OTHERWISE SPECIFIED : ±0.3**  
**DIMENSIONS : mm**

 **GROUND**  
 **I/O PORT**