

SGC Technologies, Inc.

PRODUCT SPECIFICATION FOR INFORMATION

PRODUCT NAME: SBP-3R3 TYPE

PART NO: SBP-3R3-966BP10B

Center frequency	966.875MHz
Pole	3
Bandwidth(BW)	Fo ±5MHz
Insertion Loss	3.0 dB max
Return Loss	15dB min
Ripple in BW	0.5 dB max
Attenuation	Fo ±70 MHz at 35dB min
In/Out Impedance	50 ohm

NOTE:

EQUIPMENT used :HP 8753E

DIMENSION:

TOP VIEW

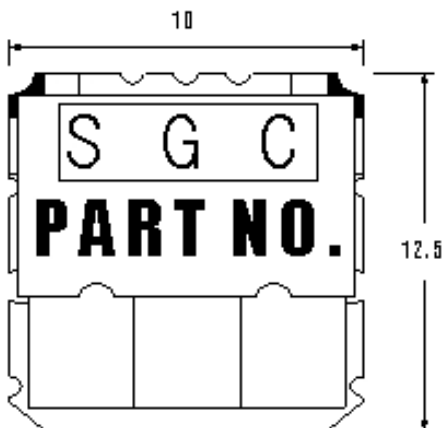

SIDE VIEW

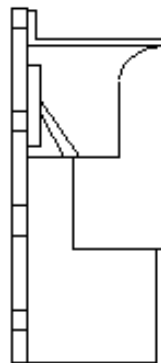

BOTTOM VIEW

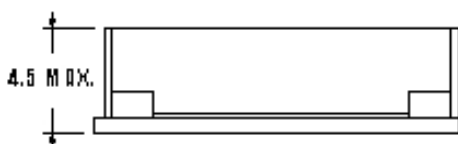
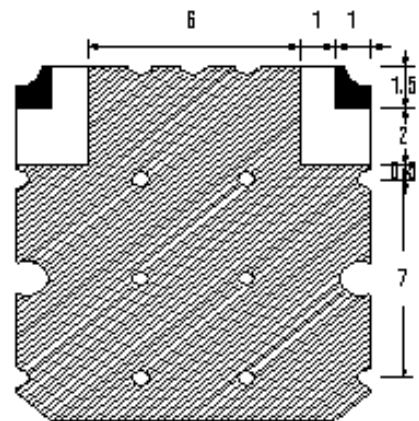

TOLERANCE UNLESS OTHERWISE SPECIFIED : ±0.3
DIMENSIONS : mm

 **GROUND**
 **I/O PORT**

SBP-3R3-966BP10B

