

SGC Technologies, Inc.

PRODUCT SPECIFICATION FOR INFORMATION

PRODUCT NAME: SBP-6R6 TYPE

PART NO: SBP-6R6-1500BP20C

Center frequency	1500MHz
Pole	6
Bandwidth(BW)	Fo ±10 MHz
Insertion Loss	4.5 dB MAX
VSWR in BW	1.5 MIN
Ripple in BW	1.0 dB MAX
Attenuation	50dB MIN at 1464 MHz 45dB MIN at 1536 MHz
In/Out Impedance	50 ohm

NOTE:

EQUIPMENT used :HP 8753E

TOP VIEW

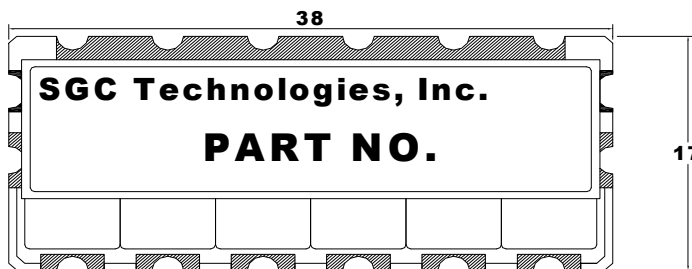

SIDE VIEW

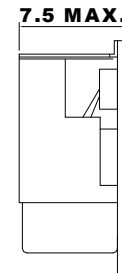

BOTTOM VIEW

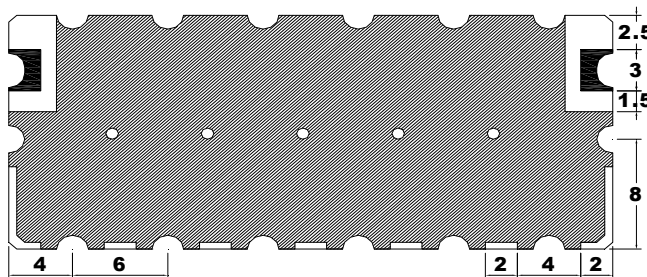

TOLERANCE UNLESS OTHERWISE SPECIFIED : ±0.3 DIMENSIONS : mm

 **GROUND**
 **I/O PORT**

SBP-6R6-1500BP20C

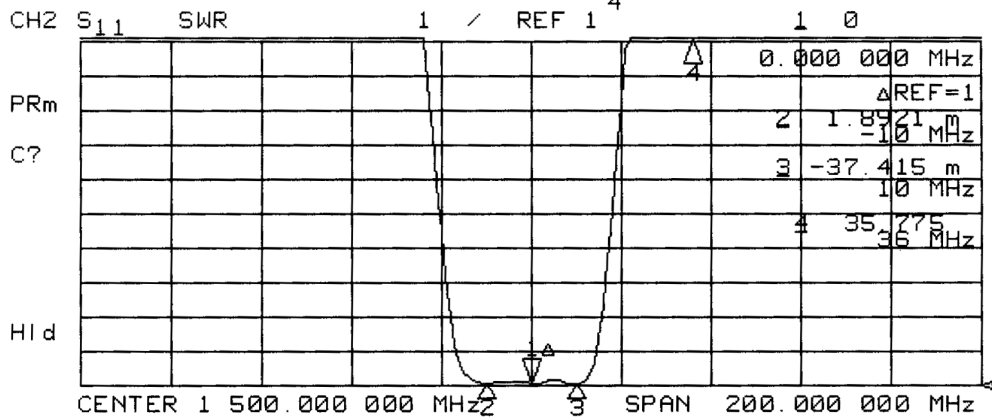
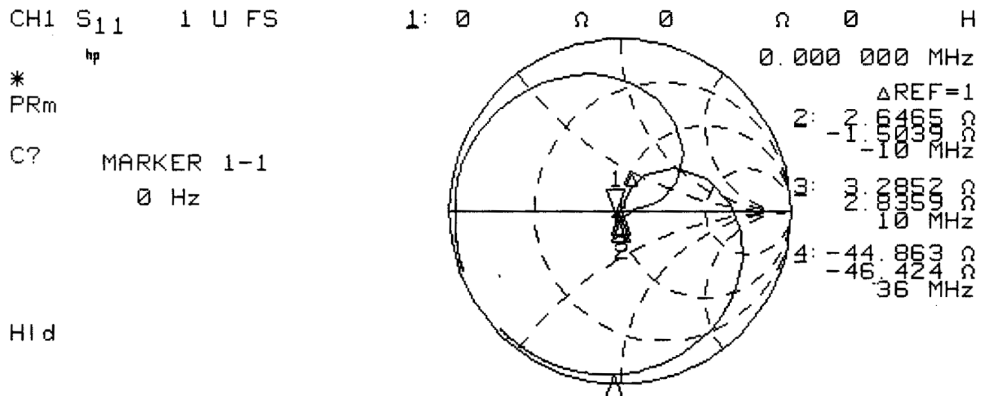
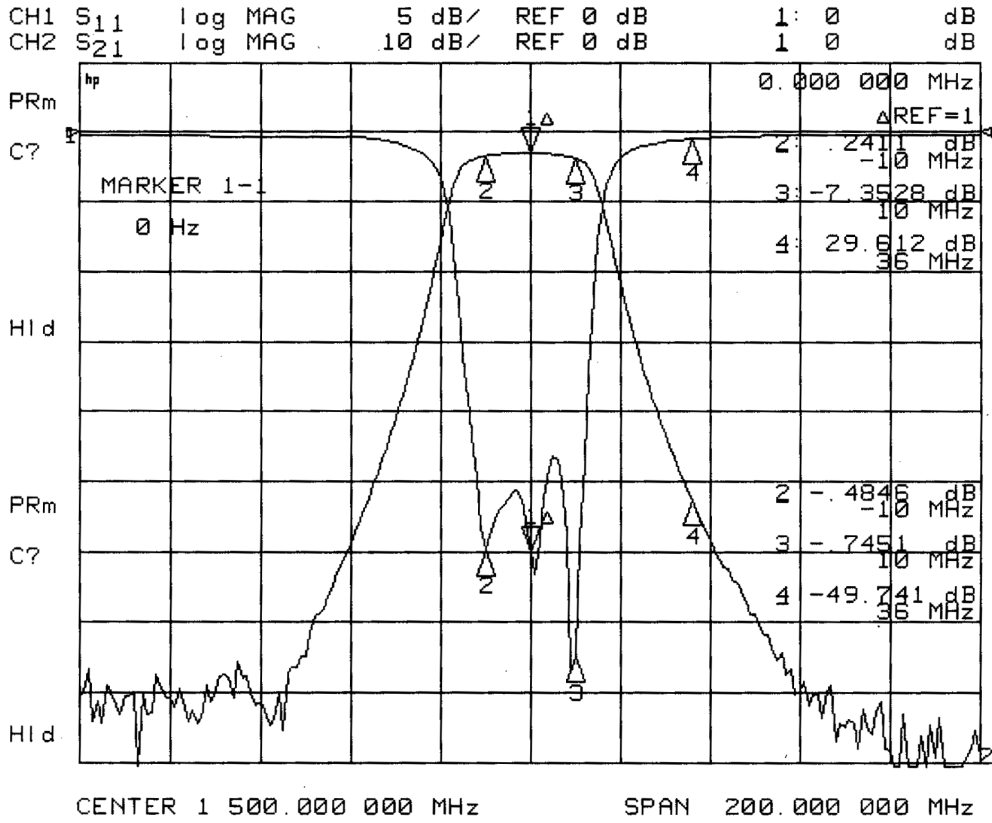

SBP-6R6-1500BP20C

CH1 S₁₁ log MAG 5 dB/ REF 0 dB 1: -30.084 dB
 CH2 S₂₁ log MAG 10 dB/ REF 0 dB 1: -2.9836 dB

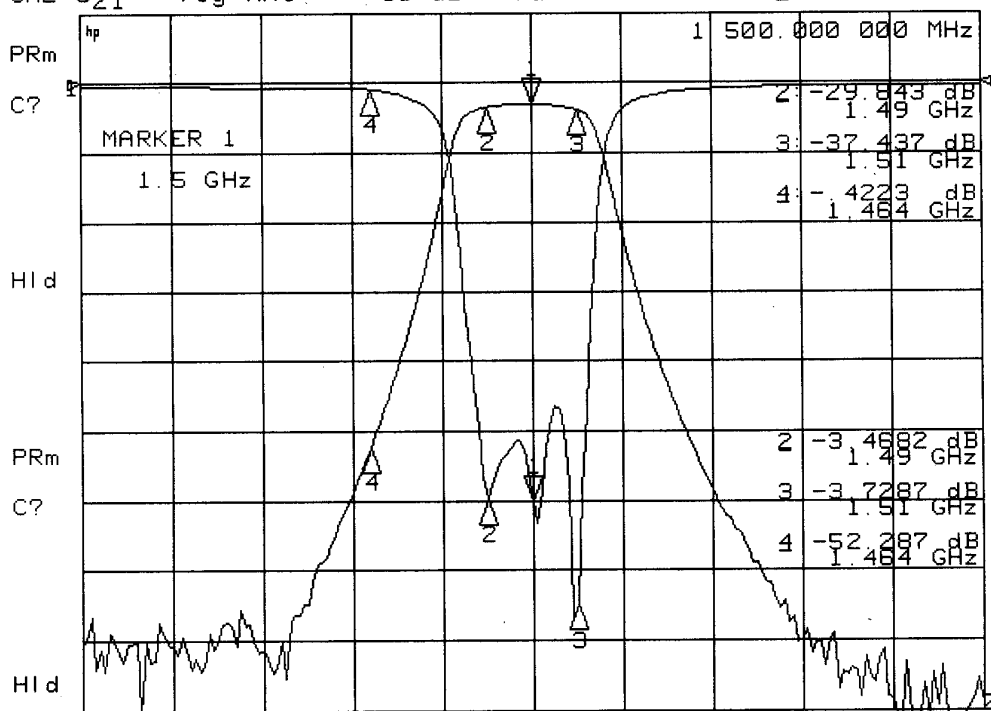

CENTER 1 500.000 000 MHz

SPAN 200.000 000 MHz

CH1 S₁₁ log MAG 5 dB/ REF 0 dB 1: -30.084 dB
 CH2 S₂₁ log MAG 10 dB/ REF 0 dB 1: -2.9836 dB

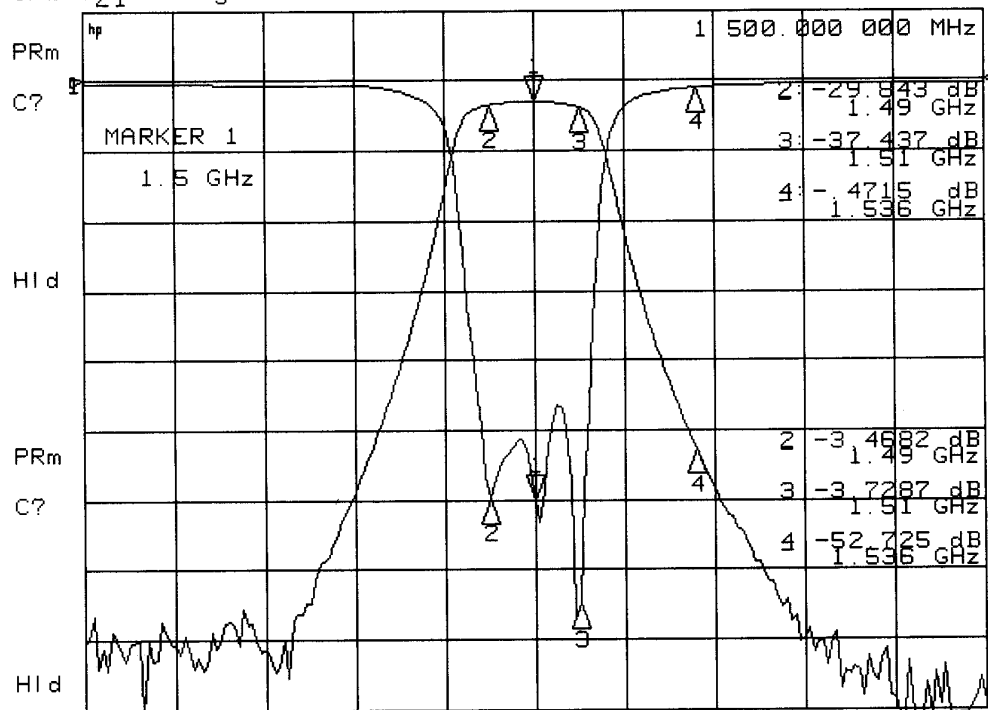

CENTER 1 500.000 000 MHz

SPAN 200.000 000 MHz