

Typical Performance

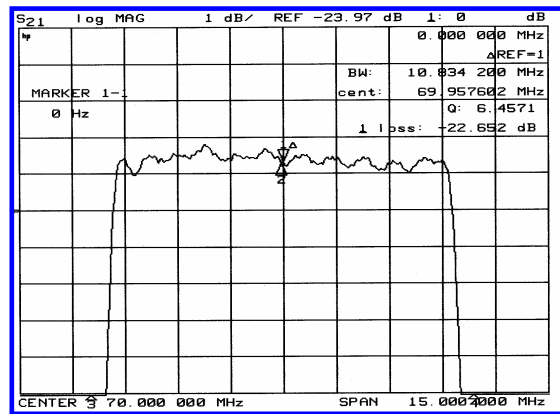
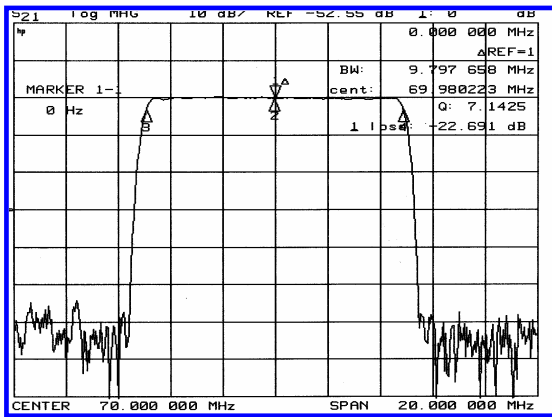

Specification

Parameter	Unit	Min.	Typ.	Max.
Center Frequency	Mhz	69.94	70.00	70.06
Insertion Loss	dB	-	23.0	24.5
3dB Bandwidth	Mhz	9.60	9.80	-
40dB Bandwidth	Mhz	-	10.85	11.00
Passband Ripple	dB	-	0.75	1.00
Group Delay Variation	nsec	-	80	120
Absolute Delay	µsec	-	2.90	-
Ultimate Attenuation	dB	50	55	-
Substrate Material	-	128LiNbO ₃		

Package Dimension

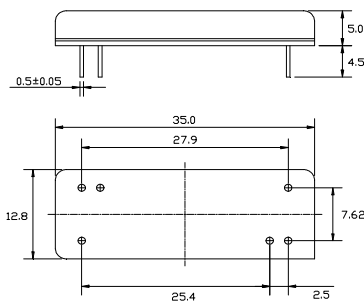

Matching Configuration

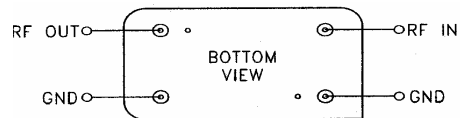

Bottom View
Source / Load Impedance = 50Ω
Ambient Temperature = 25°C