

Typical Performance

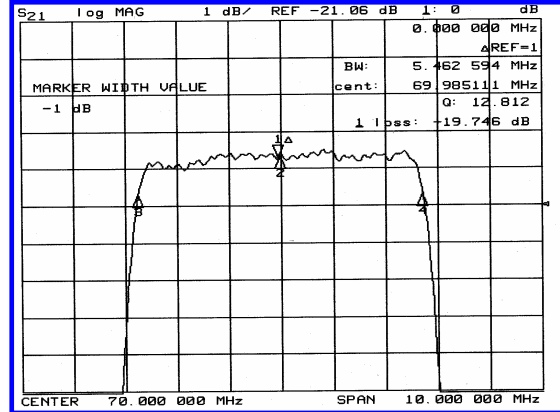
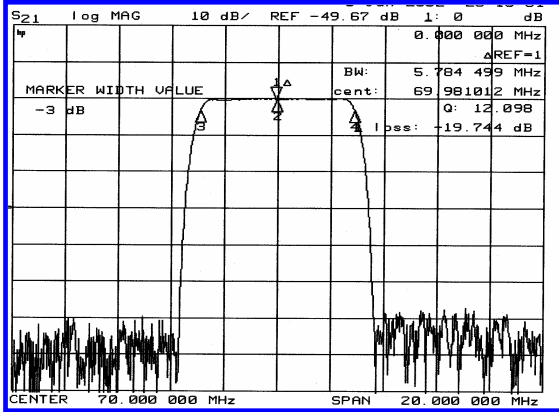

Specification

Parameter	Unit	Min.	Typ.	Max.
Center Frequency	Mhz	69.92	70.00	70.08
Insertion Loss	dB		20.00	21.50
3dB Bandwidth	Mhz	5.60	5.78	
40dB Bandwidth	Mhz		7.07	7.20
Passband Ripple	dB		0.45	0.80
Group Delay Variation	nsec		100	200
Absolute Delay	usec		2.55	
Ultimate Attenuation	dB	50	60	
Substrate Material	-		YZ-LiNbO <sub>3</sub>	

Package Dimension

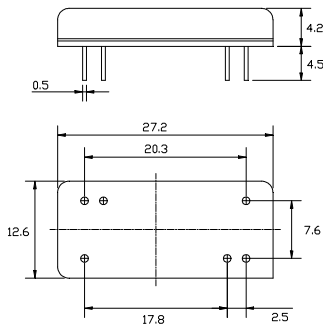

Matching Configuration

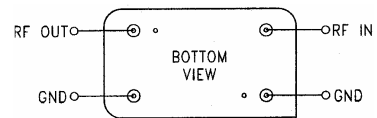

Bottom View  
Source / Load Impedance = 50Ω  
Ambient Temperature = 25°C