

Typical Performance

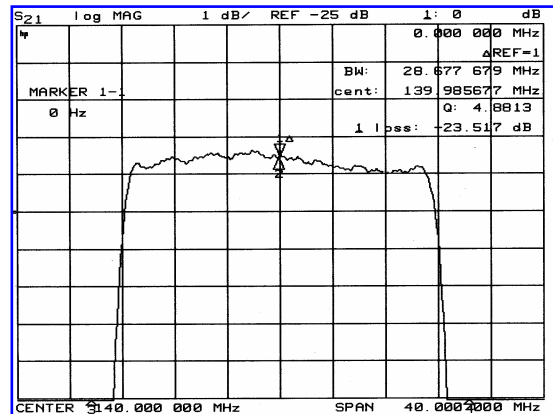
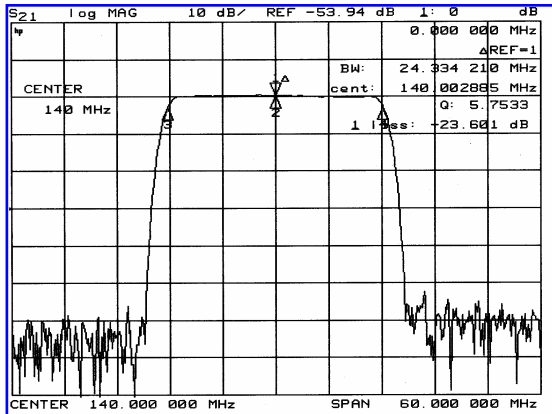

Specification

Parameter	Unit	Min.	Typ.	Max.
Center Frequency	Mhz	139.85	140.00	140.15
Insertion Loss	dB		23.5	25.0
3dB Bandwidth	Mhz	24.00	24.30	
40dB Bandwidth	Mhz		28.60	29.50
Passband Ripple	dB		0.65	1.00
Group Delay Variation	nsec		20	50
Absolute Delay	usec		1.15	
Ultimate Attenuation	dB	50	60	
Substrate Material	-		128 LiNbO ₃	

Package Dimension

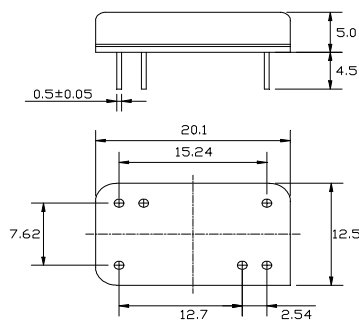

Matching Configuration

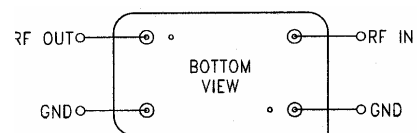

Bottom View
Source / Load Impedance = 50Ω
Ambient Temperature = 25°C