

Typical Performance

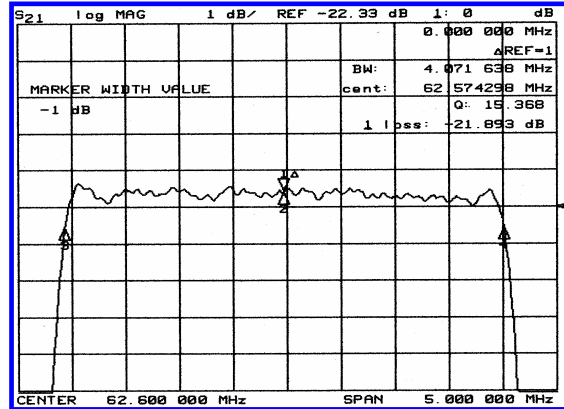
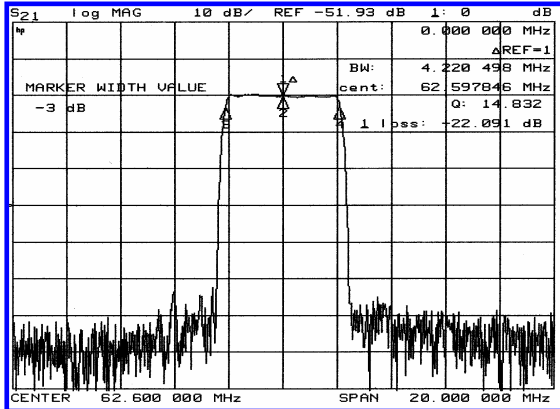

Specification

Parameter	Unit	Min.	Typ.	Max.
Center Frequency	Mhz	62.52	62.60	62.68
Insertion Loss	dB	-	22.00	24.00
1dB Bandwidth	Mhz	4.00	4.07	
3dB Bandwidth	Mhz	4.20	4.22	-
50dB Bandwidth	Mhz	-	4.86	5.00
Passband Ripple	dB	-	0.65	1.00
Group Delay Variation	nsec	-	200	300
Absolute Delay	µsec	-	4.50	-
Ultimate Attenuation	dB	50	55	-
Substrate Material	-	YZ-LiNbO ₃		

Package Dimension

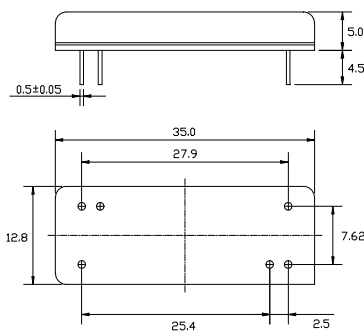

Matching Configuration

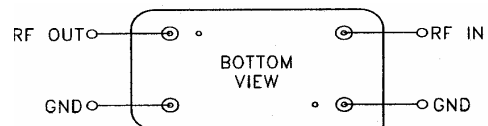

No Matching Required
Source / Load Impedance = 50Ω
Ambient Temperature = 25°C