

Typical Performance

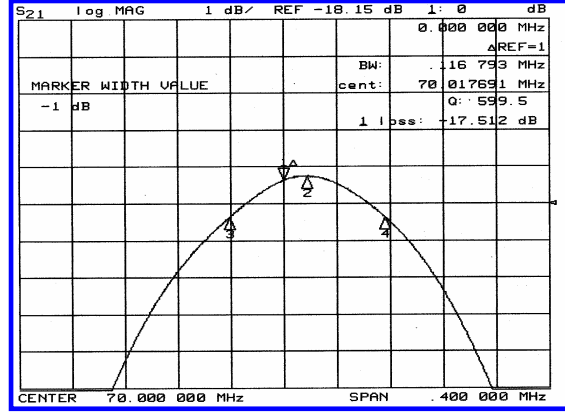
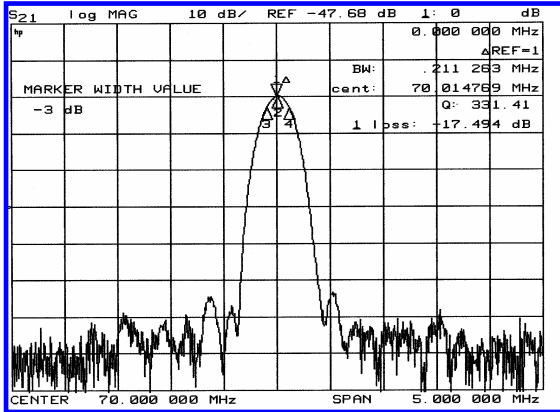

Specification

Parameter	Unit	Min.	Typ.	Max.
Center Frequency	Mhz	69.94	70.00	70.06
Insertion Loss	dB	-	17.50	19.00
1dB Bandwidth	Mhz	0.10	0.12	-
3dB Bandwidth	Mhz	0.18	0.20	-
40dB Bandwidth	Mhz	-	0.65	0.80
Passband Ripple	dB	-	0.35	0.50
Group Delay Variation	nsec	-	300	500
Absolute Delay	µsec	-	4.35	-
Ultimate Attenuation	dB	50	55	-
Substrate Material	-	Quartz		

Package Dimension

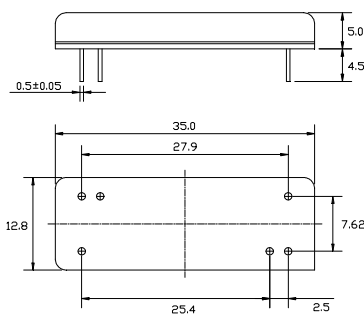

Matching Configuration

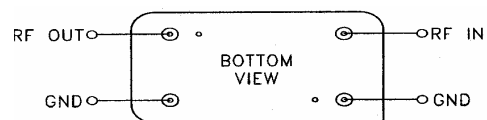

No Matching Required
Source / Load Impedance = 50Ω
Ambient Temperature = 25°C