

Typical Performance

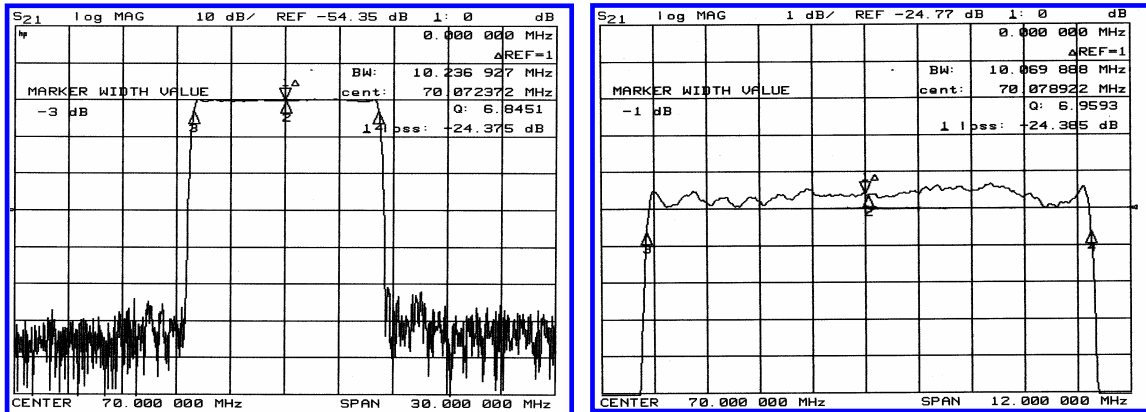

Specification

Parameter	Unit	Min.	Typ.	Max.
Center Frequency	Mhz	69.92	70.00	70.08
Insertion Loss	dB	-	24.5	26.0
1dB Bandwidth	Mhz	10.00	10.06	-
3dB Bandwidth	Mhz	10.20	10.23	-
40dB Bandwidth	Mhz	-	10.93	11.10
Passband Ripple	dB	-	0.85	1.00
Group Delay Variation	nsec	-	70	120
Absolute Delay	µsec	-	3.8	-
Ultimate Attenuation	dB	50	55	-
Substrate Material	-	128-LiNbO ₃		
Temperature Coefficient	ppm/°C	-72		

Package Dimension

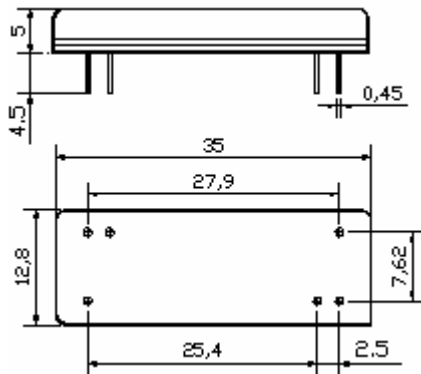

Matching Configuration

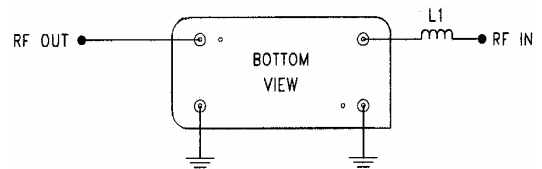

L1 = 0.39µH
Source / Load Impedance = 50Ω
Ambient Temperature = 25°C