

Typical Performance

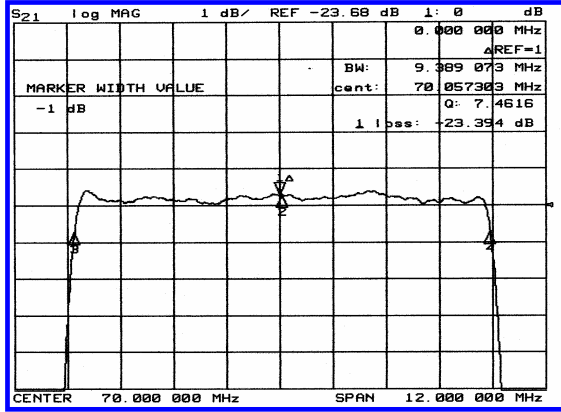
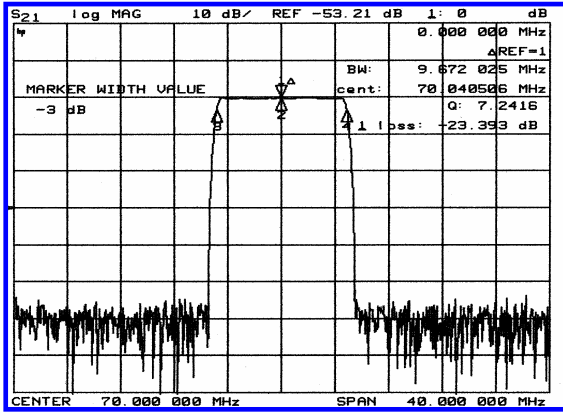

Specification

Parameter	Unit	Min.	Typ.	Max.
Center Frequency	Mhz	69.92	70.00	70.08
Insertion Loss	dB	-	23.5	24.5
1dB Bandwidth	Mhz	9.20	9.38	-
3dB Bandwidth	Mhz	9.50	9.67	-
40dB Bandwidth	Mhz	-	10.81	11.00
Passband Ripple	dB	-	0.55	1.00
Group Delay Variation	nsec	-	80	150
Absolute Delay	µsec	-	2.6	-
Ultimate Attenuation	dB	50	55	-
Substrate Material	-	128-LiNbO ₃		
Temperature Coefficient	ppm/°C	-72		

Package Dimension

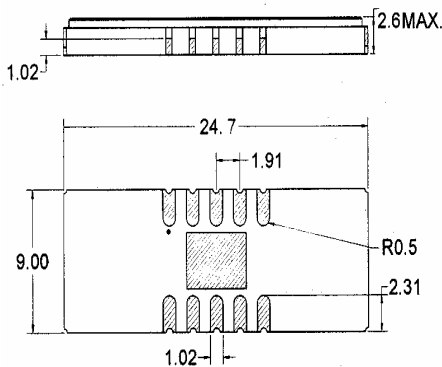

Matching Configuration

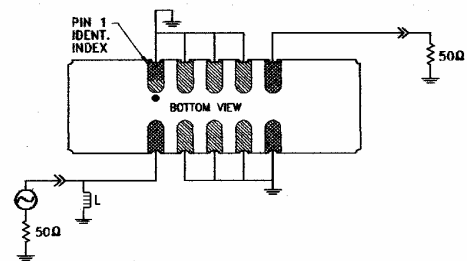

L1 = 0.15µH
Source / Load Impedance = 50Ω
Ambient Temperature = 25°C